

Thermo Scientific TSQ Quantiva
Triple-Stage Quadrupole
Mass Spectrometer

Extreme quantitative performance
with unprecedented ease

Thermo
SCIENTIFIC



Unsurpassed quantitation

Continual changes in research and regulatory requirements drive the need for ever-lower limits of detection and quantitation. A modern triple quadrupole LC-MS system must be capable of attaining the lowest LODs and LOQs run after run and day after day, regardless of sample type or matrix. The Thermo Scientific™ TSQ Quantiva™ triple-stage quadrupole mass spectrometer uses active ion management to exceed even the most stringent analytical requirements with superb sensitivity, speed, and dynamic range. It does so with an ease of operation—from method development through routine maintenance—that allows users to spend more time thinking about their research and less time worrying about instrument setup and operation.

Attogram sensitivity

Research samples are frequently limited and precious. The TSQ Quantiva mass spectrometer makes the most of every attogram. Innovations increase signal and selectivity, decrease noise, and boost dynamic range and scan speed. The result is the ability to quantify the most complex and challenging samples with extreme sensitivity.

Unprecedented usability

The TSQ Quantiva mass spectrometer's exemplary analytical performance doesn't come at the price of complexity or lack of durability. Breakthrough software and hardware innovations make operation simple and intuitive. An entirely new drag-and-drop method editor simplifies method development and eliminates separate tune files. Integration with application-specific software ensures maximum productivity. A plug-and-play ion source eliminates manual gas and electrical connections and is automatically detected on installation.



Sensitive, robust peptide quantitation

Putative biomarkers and other proteins of scientific interest are frequently obscured by common high-abundance proteins. The TSQ Quantiva MS and Thermo Scientific™ EASY-Spray NG™ ion source supply the sensitivity, precision, and dynamic range needed to screen for and validate such elusive targets. Thermo Scientific™ Pinpoint™ software leverages previously acquired discovery data to vastly simplify development and running of targeted SRM methods.

Total solutions for clinical research and forensic toxicology

The cutting edge of clinical research or forensic toxicology doesn't allow for compromises between the lowest LODs and LOQs, precision, and reliability. The TSQ Quantiva MS ensures fast, sensitive, reproducible quantitation of precious, fragile samples. Simplified methods make operation straightforward for experts and non-experts alike.

Industry-leading sensitivity for environmental and food testing

New and existing threats to the environment and food supply are leading to increasingly stringent regulations. The TSQ Quantiva system makes it easier to keep up with them. A drag-and-drop method editor and close integration with Thermo Scientific™ TraceFinder™ software make development of ultrasensitive yet reliable screening methods faster and easier than ever.

Highly productive pharmaceutical research

Pharmaceutical research demands high productivity with uncompromising performance. The sensitivity, dynamic range, and industry-leading selectivity of the TSQ Quantiva MS, and its powerful but simple method editor, make it the perfect instrument for developing quantitative assays. Thermo Scientific™ LCQuan™ software provides 21 CFR Part 11-compliant data analysis and compatibility with Thermo Scientific™ Watson™ LIMS systems.

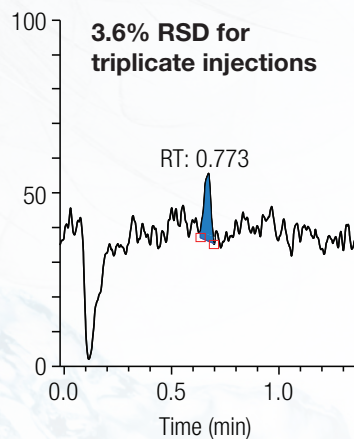
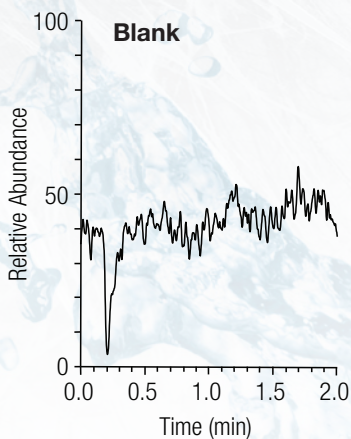

▲ 70 attograms of verapamil in plasma on column ... ~ 92,000 molecules!

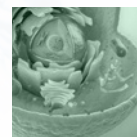

AIM technology delivers extreme sensitivity and excellent robustness

When the goal is maximum possible sensitivity, speed, and robustness in a triple quadrupole mass spectrometer, every aspect of design must be examined. Every lens transition, every fringing field, and every mechanical and electrical tolerance must be considered and optimized in concert. The result of this exercise is Thermo Scientific™ Active Ion Management (AIM™) technology. AIM technology maximizes ion transmission, eliminates major sources of noise, and precisely isolates analytes to achieve extreme quantitative performance.



GREATER SENSITIVITY

The electrodynamic ion funnel (EDIF) efficiently focuses the cloud of ions leaving the transfer tube. Its broad transmission curve reduces ion losses and increases sensitivity. The EDIF also reduces in-source fragmentation.

ENHANCED ION TRANSMISSION

The high-capacity transfer tube (HCTT) with its large rectangular orifice transmits more ions while maintaining excellent desolvation.

MORE ROBUST OPERATION

An enhanced exhaust port with constant nitrogen flush removes more solvent vapor, reducing baseline noise and increasing uptime.

EASIER TO USE

Ion Max NG ion source makes all gas and electrical connections automatically on installation. It accommodates HESI, APCI, and combined HESI/APCI probes, which can be swapped quickly, without tools.

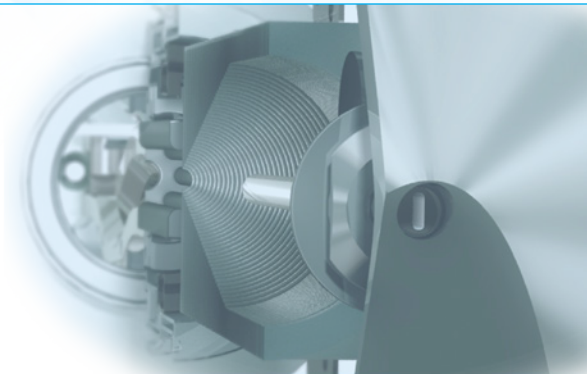

HIGH-CAPACITY TRANSFER TUBE

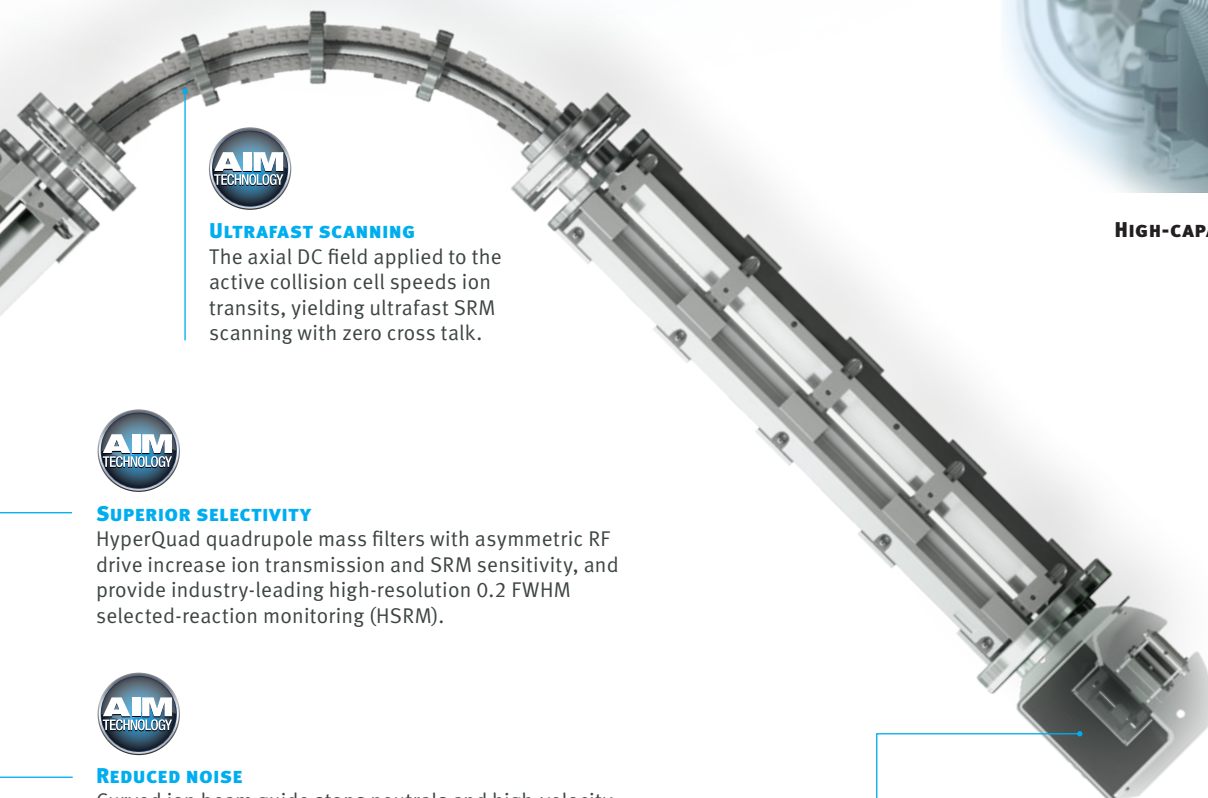

ULTRAFAST SCANNING

The axial DC field applied to the active collision cell speeds ion transits, yielding ultrafast SRM scanning with zero cross talk.



SUPERIOR SELECTIVITY

HyperQuad quadrupole mass filters with asymmetric RF drive increase ion transmission and SRM sensitivity, and provide industry-leading high-resolution 0.2 FWHM selected-reaction monitoring (HSRM).



REDUCED NOISE

Curved ion beam guide stops neutrals and high-velocity clusters with a neutral blocker, keeping the ion optics cleaner, reducing noise, and increasing sensitivity.

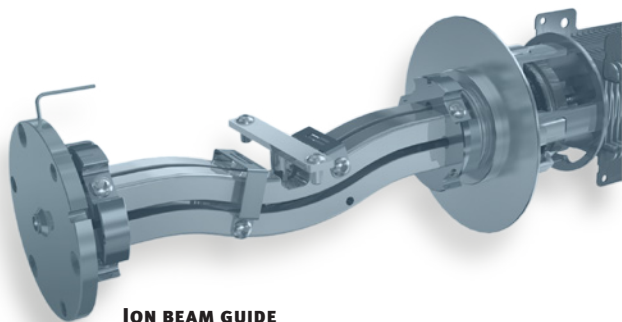

ION BEAM GUIDE

GREATER SENSITIVITY AND DYNAMIC RANGE

Dual-mode discrete-dynode detector increases sensitivity by operating in pulse-counting mode when ion flux is low and analog mode when ion flux is high. Six orders of dynamic range provide high-confidence quantitation.



Simplified, integrated software delivers performance with ease

Integral to the TSQ Quantiva system is entirely new software for method development and instrument operation; software that ensures more performance with less effort. The drag-and-drop method editor simplifies method development and does away with cumbersome tune files. Close integration with workflow-specific software packages ensures seamless, effective operation for even the most challenging applications. TSQ Quantiva software helps researchers focus on their science instead of their instruments.

PROTEIN AND PEPTIDE QUANTIFICATION

250 pesticides in onion matrix at 1 ppb analyzed in a single run at 500 SRM/s

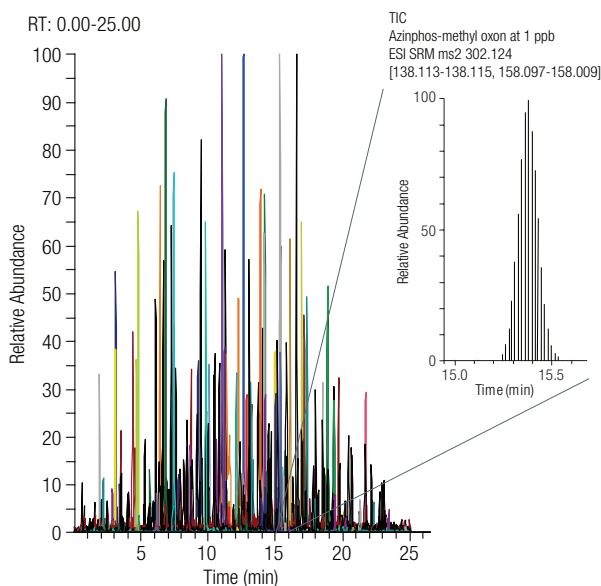

ENVIRONMENTAL AND FOOD SAFETY

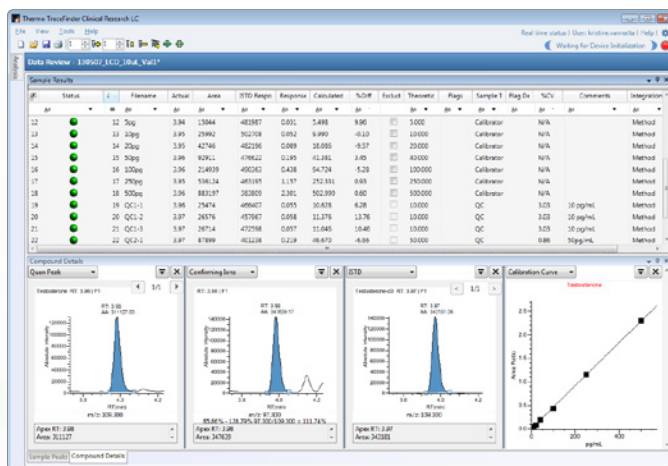

TRACEFINDER SOFTWARE

TraceFinder software provides an extensive set of built-in SRM methods, compound data stores, and preconfigured report templates for environmental, food safety, clinical research, and forensic toxicology applications.

▲ Testosterone analyzed with sensitivity and reproducibility

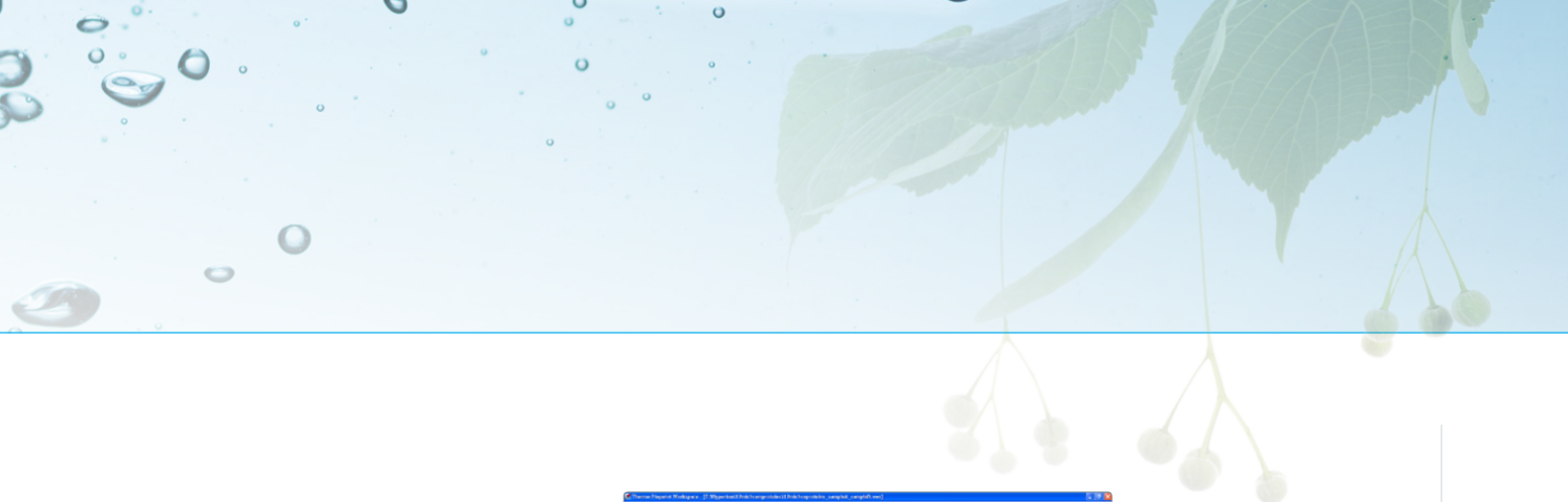

PINPOINT SOFTWARE

Pinpoint software leverages previously acquired discovery data, and the commonality between MS platforms, to largely automate the development of intelligent SRM assays for targeted protein quantitation. It also streamlines data acquisition and analysis, and the resulting data can be used to further refine the method.

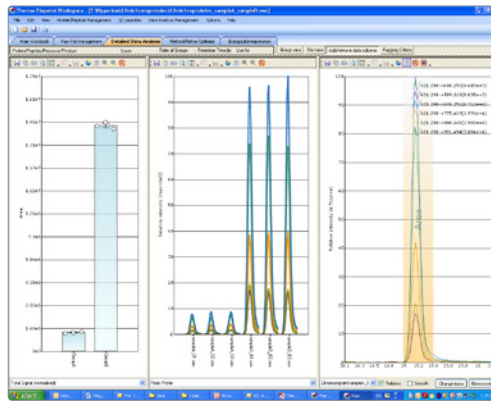
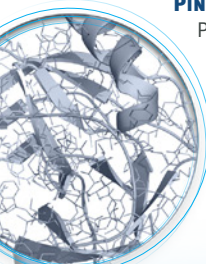

Pinpoint software automates and simplifies quantitation of proteins and peptides



LCQUAN SOFTWARE

LCQuan software is a 21 CFR Part 11-compliant solution for method development, data review, processing, reporting, and data export in drug discovery and development experiments. It is fully compatible with the industry-standard Watson LIMS system.

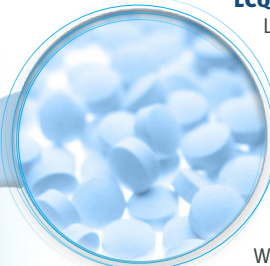

PHARMACEUTICAL ANALYSIS

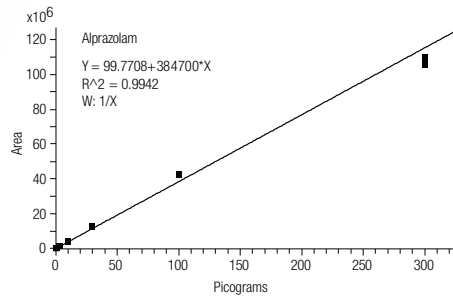

Alprazolam analyzed over 6 orders of dynamic range with superb reproducibility

CLINICAL RESEARCH AND FORENSIC TOXICOLOGY



Levels	RSD
0.3 fg	9.50%
3 fg	3.01%
30 fg	1.03%
300 fg	0.99%
3 pg	0.52%
30 pg	0.41%
300 pg	1.27%

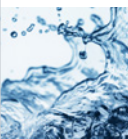

Transforming science with the next generation of mass spectrometers

The TSQ Quantiva mass spectrometer is just one of a family of transformational, next-generation Thermo Scientific mass spectrometers that combine unprecedented performance and usability. Others include:

- Thermo Scientific™ TSQ Endura™ triple-stage quadrupole mass spectrometer
- Thermo Scientific™ Orbitrap Fusion™ Tribrid™ mass spectrometer

These next-generation instruments are built on a foundation of shared, state-of-the-art hardware and software components. This commonality makes it easier to transfer methods from one instrument to another when research progresses from single-sample-based experiments to validation and high-volume screening or routine quantification.



All of these Thermo Scientific mass spectrometers can be paired with a range of high-performance Thermo Scientific LC systems. Regardless of application, there is an LC that will ensure the highest possible performance.



For Research Use Only. Not for use in diagnostic procedures.

www.thermofisher.com

©2016 Thermo Fisher Scientific Inc. All rights reserved. All trademarks are the property of Thermo Fisher Scientific Inc. and its subsidiaries. Specifications, terms and pricing are subject to change. Not all products are available in all countries. Please consult your local sales representative for details.

Africa-Other +27 11 570 1840
Australia +61 3 9757 4300
Austria +43 1 333 50 34 0
Belgium +32 53 73 42 41
Canada +1 800 530 8447
China +86 10 8419 3588
Denmark +45 70 23 62 60

Europe-Other +43 1 333 50 34 0
Finland/Norway/Sweden
+46 8 556 468 00
France +33 1 60 92 48 00
Germany +49 6103 408 1014
India +91 22 6742 9434
Italy +39 02 950 591

Japan +81 45 453 9100
Latin America +1 561 688 8700
Middle East +43 1 333 50 34 0
Netherlands +31 76 579 55 55
New Zealand +64 9 980 6700
Russia/CIS +43 1 333 50 34 0
South Africa +27 11 570 1840

Spain +34 914 845 965
Switzerland +41 61 716 77 00
UK +44 1442 233555
USA +1 800 532 4752

BR63842_E 08/16

Thermo
SCIENTIFIC
Part of Thermo Fisher Scientific